

# Individual designed room sensors with MODBUS+ASCII protocol

## RESI-RS-xxx-MB-dd-oo

Room sensors for wall mount with serial RS485 interface and individual design

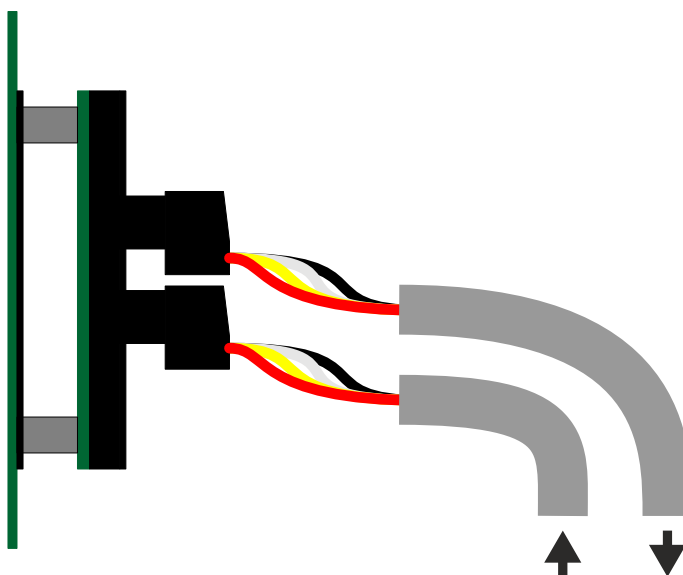
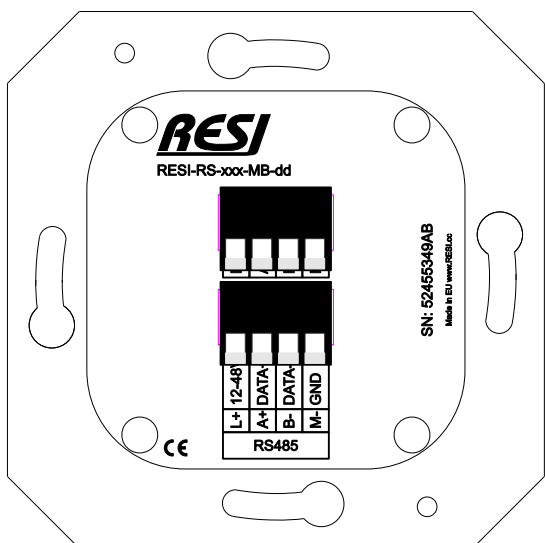
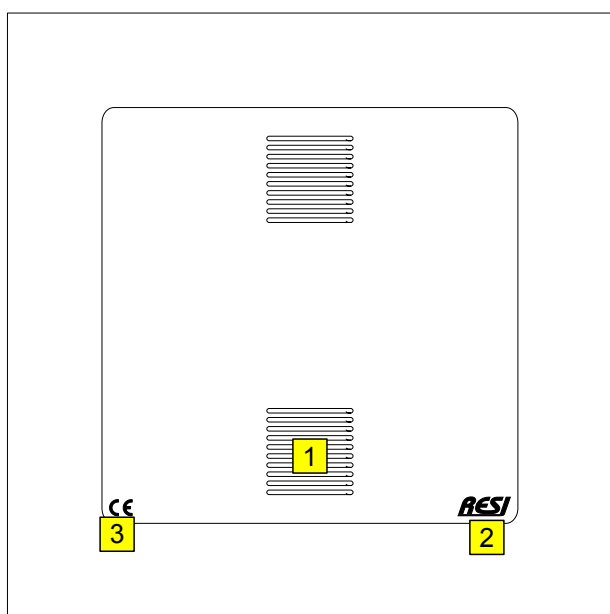
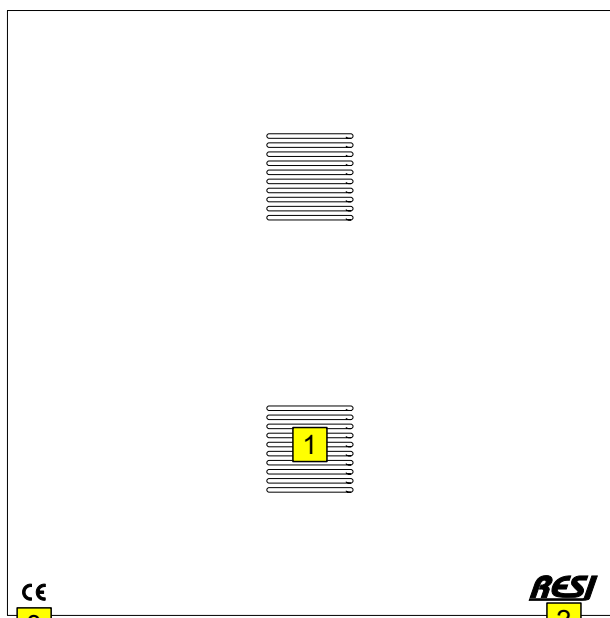

### ORDER CODE

RESI-RS-xxx-MB-dd

dd:DESIGN

Select your design option

xxx:INTEGRATED SENSOR



- N1 or none:No sensors
- T1:Temperature
- TH1:Temperature+rel. humidity
- AQ1:T+rel. humidity+Air quality
- CO2:CO2 sensor
- CO2AQ1:CO2+T+rel. humidity+Air quality



## RESI-RS-xxx-MB-dd-oo

Room sensors for wall mount with serial RS485 interface and individual design

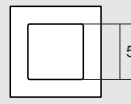
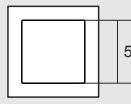
CFG 2/4 EN

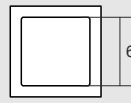
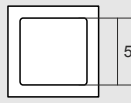
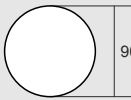
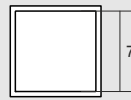
1:CUTOUT DESIGN		2:LOGO		3:CE SIGN	
<input type="checkbox"/>	A: 	<input type="checkbox"/>	A:STANDARD	<input type="checkbox"/>	A:STANDARD
<input type="checkbox"/>	B: 	<input type="checkbox"/>	B:NO LOGO	<input type="checkbox"/>	B:NO CE SIGN
<input type="checkbox"/>	C: NO CUTOUT	<input type="checkbox"/>	C:CUSTOM BRAND		
		Specify your brand name here: _____			

DESIGN					
<input type="checkbox"/>	<b>RA</b> RESI DESIGN A O:80x80	<input type="checkbox"/>	<b>SD55</b> SIEMENS DELTA I:55x55	<input type="checkbox"/>	<b>GE2</b> GIRA E2 I:55.5x55.5
					
<input type="checkbox"/>	<b>RB</b> RESI DESIGN B O:80x80	<input type="checkbox"/>	<b>SD68</b> SIEMENS DELTA I:68x68	<input type="checkbox"/>	<b>BQ3</b> BERKER Q3 I:59x59
					
<input type="checkbox"/>	<b>RC</b> RESI DESIGN C Φ:90	<input type="checkbox"/>	<b>JLS</b> JUNG LS 982 I:71x71	<b>NOTE</b> The necessary third party frames are not part of our standard product delivery and product pricing!  But we can deliver those frames as extra addon products, if you want!	
					

BASIC MATERIAL		
<input type="checkbox"/>	White-Black	
<input type="checkbox"/>	Black-White	
<input type="checkbox"/>	Silver-Black	
<input type="checkbox"/>	Yellow-Black	
<input type="checkbox"/>	Red-White	
<input type="checkbox"/>	Orange-White	
<input type="checkbox"/>	Blue-White	
<input type="checkbox"/>	Purple-White	
<input type="checkbox"/>	Green-White	
<input type="checkbox"/>	Opal Green-White	
<input type="checkbox"/>	Brushed Nickel-Black	
<input type="checkbox"/>	Gold-Black	
<input type="checkbox"/>	Brushed Copper-Black	
<input type="checkbox"/>	Deep Bronze-Black	
<input type="checkbox"/>	Brushed Bronze-Black	
<input type="checkbox"/>	Brushed Gold-Black	
<input type="checkbox"/>	Brushed Aluminium-Black	
<input type="checkbox"/>	Stainless Steel-Black	
<input type="checkbox"/>	Stainless Steel-Blue	

# Individual designed room sensors with MODBUS+ASCII protocol

## RESI-RS-xxx-MB-dd-oo

Room sensors for wall mount with serial RS485 interface and individual design

CFG 3/4

EN

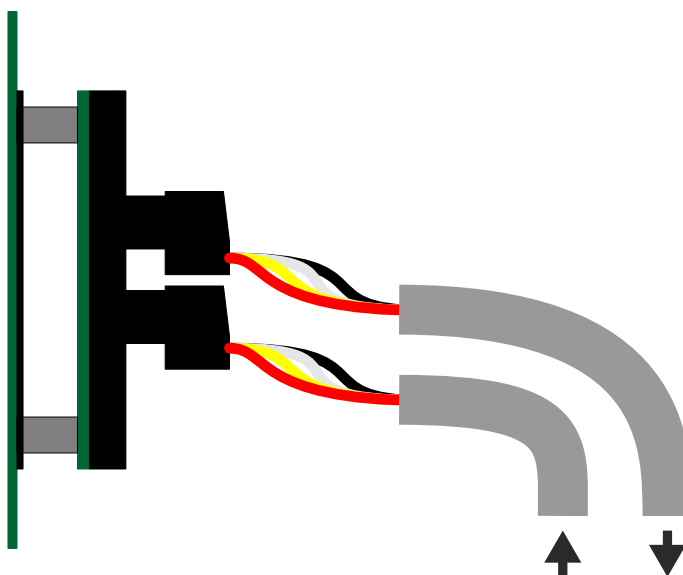
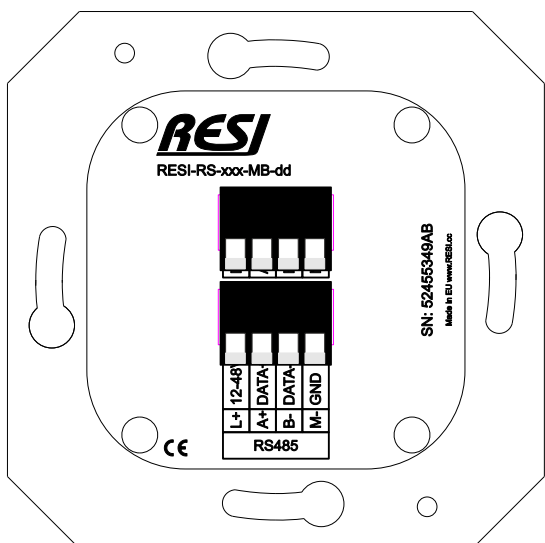
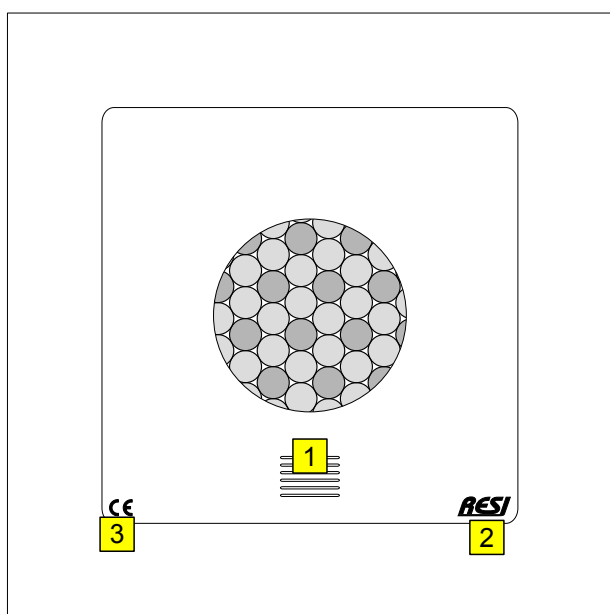
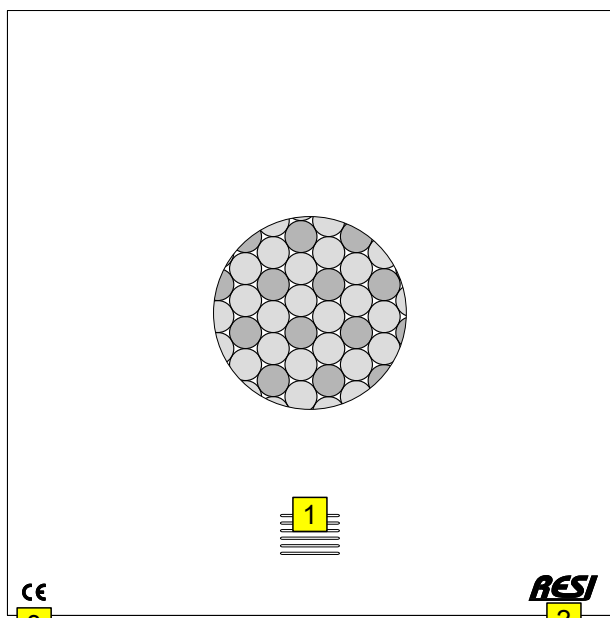

### ORDER CODE

RESI-RS-xxx-MB-dd

dd:DESIGN

Select your design option

### xxx:INTEGRATED SENSOR

- N1 or none:No sensors
- MD1:PIR motion+brightness
- OD1:PIR occupancy+brightness
- MDT1:PIR motion+brightness+temperature
- ODT1:PIR occupancy+brightness+temperature
- MDAQ1:PIR motion+B+T+rel. H+Air quality
- ODAQ1:PIR occupancy+B+T+rel. H+Air

<b>1: CUTOUT DESIGN</b>		<b>2: LOGO</b>		<b>3: CE SIGN</b>	
<input type="checkbox"/> A:		<input type="checkbox"/> A: STANDARD		<input type="checkbox"/> A: STANDARD	
<input type="checkbox"/> B:		<input type="checkbox"/> B: NO LOGO		<input type="checkbox"/> B: NO CE SIGN	
<input type="checkbox"/> C: NO CUTOUT		<input type="checkbox"/> C: CUSTOM BRAND			
		Specify your brand name here: _____			

DESIGN		
<input type="checkbox"/> RA	RESI DESIGN A O: 80x80	<input type="checkbox"/> SD55 SIEMENS DELTA I: 55x55
<input type="checkbox"/> RB	RESI DESIGN B O: 80x80	<input type="checkbox"/> SD68 SIEMENS DELTA I: 68x68
<input type="checkbox"/> RC	RESI DESIGN C Φ: 90	<input type="checkbox"/> JLS JUNG LS 982 I: 71x71
		<b>NOTE</b> The necessary third party frames are not part of our standard product delivery and product pricing! But we can deliver those frames as extra addon products, if you want!

BASIC MATERIAL	
<input type="checkbox"/>	White-Black
<input type="checkbox"/>	Black-White
<input type="checkbox"/>	Silver-Black
<input type="checkbox"/>	Yellow-Black
<input type="checkbox"/>	Red-White
<input type="checkbox"/>	Orange-White
<input type="checkbox"/>	Blue-White
<input type="checkbox"/>	Purple-White
<input type="checkbox"/>	Green-White
<input type="checkbox"/>	Opal Green-White
<input type="checkbox"/>	Brushed Nickel-Black
<input type="checkbox"/>	Gold-Black
<input type="checkbox"/>	Brushed Copper-Black
<input type="checkbox"/>	Deep Bronze-Black
<input type="checkbox"/>	Brushed Bronze-Black
<input type="checkbox"/>	Brushed Gold-Black
<input type="checkbox"/>	Brushed Aluminium-Black
<input type="checkbox"/>	Stainless Steel-Black
<input type="checkbox"/>	Stainless Steel-Blue